

PRODOTTI / RICAMBI
PRODUCTS / SPARE PARTS
PRODUITS / PIÈCES DÉTACHÉES
PRODUKTE / ERSATZTEILE
PRODUCTOS / REPUESTOS

TALENTO

Esplosi
Versioni Special / Plus

20/12/2016

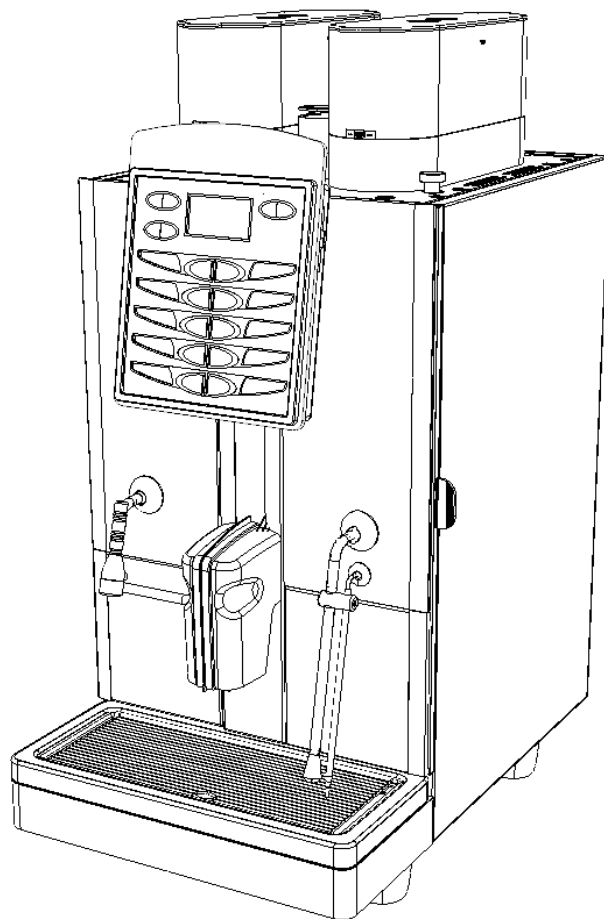

 nuova
SIMONELLI®

I N D I C E

- » TAV 01 - COMPONENTI GRUPPO CARENA
- » TAV 02 - COMPONENTI PORTA SERVIZI FRONTALE
- » TAV 03 - COMPONENTI GRUPPO TELAIO
- » TAV 03 MK - COMPONENTI LATTE
- » TAV 04 - COMPONENTI GRUPPO POMPA
- » TAV 05 - COMPONENTI IDRAULICI STANDARD
- » TAV 06 - COMPONENTI IDRAULICI KIT ECONOMIZZATORE
- » TAV 07 - COMPONENTI GRUPPO EROGAZIONE
- » TAV 08 - COMPONENTI GRUPPO CALDAIE
- » TAV 09 - COMPONENTI ELETTRICI ED ELETTRONICI

» LEGENDA :

I CODICI SCRITTI IN GRASSETTO SI RIFERISCONO AI COMPONENTI IMPIEGATI ATTUALMENTE.

I CODICI IMPIEGATI PRIMA SONO SCRITTI IN CORSIVO CON INDICATA A FIANCO LA DATA DI FINE VALIDITA'.

ESEMPIO:

03001531 - 01/09/2007
03001531



COMPONENTI GRUPPO CARENA

BODYWORK COMPONENTS

T
A
L
E
N
T
O

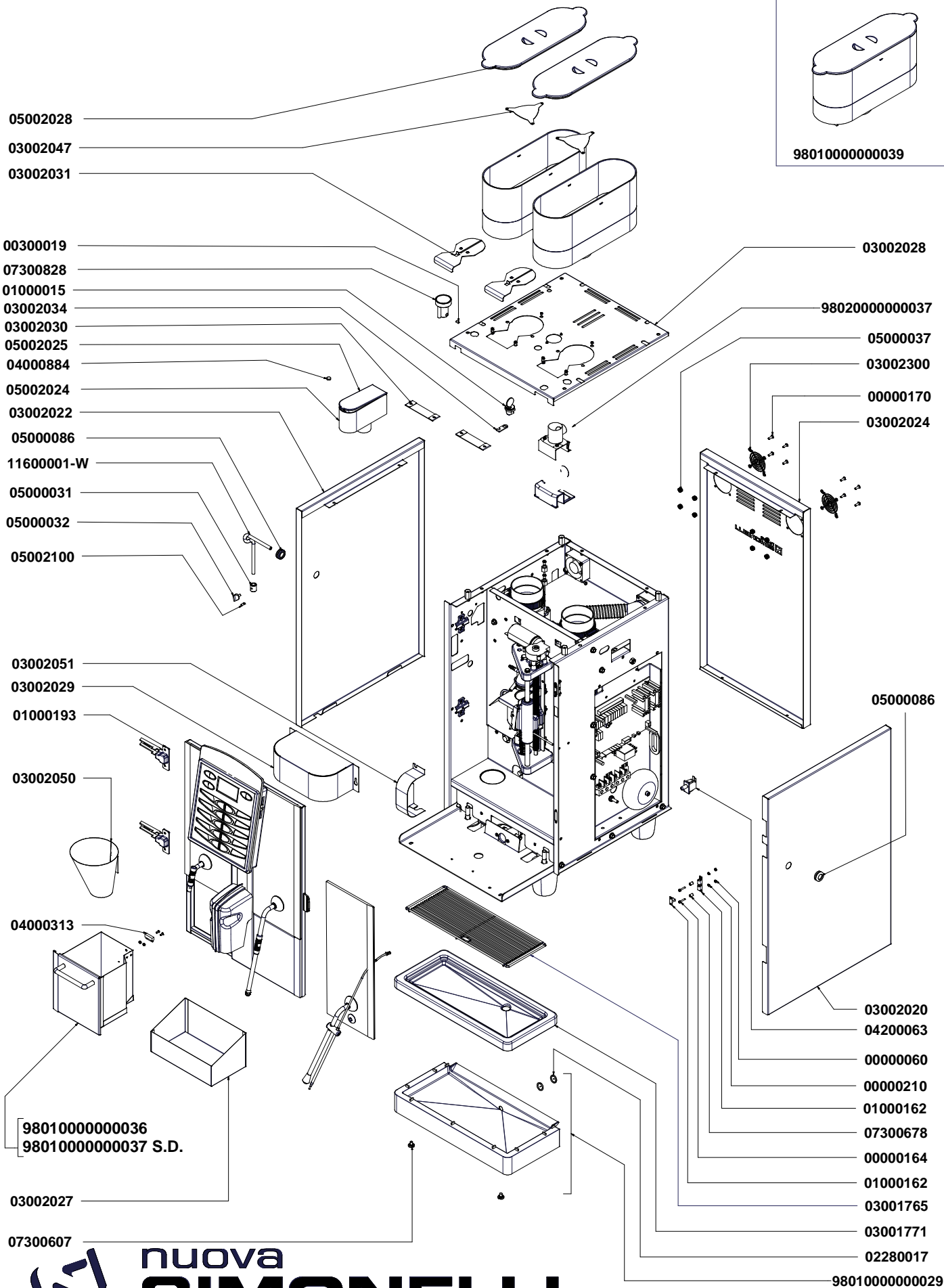

PORTA SERVIZI FRONTALE SERVICES DOOR PANEL

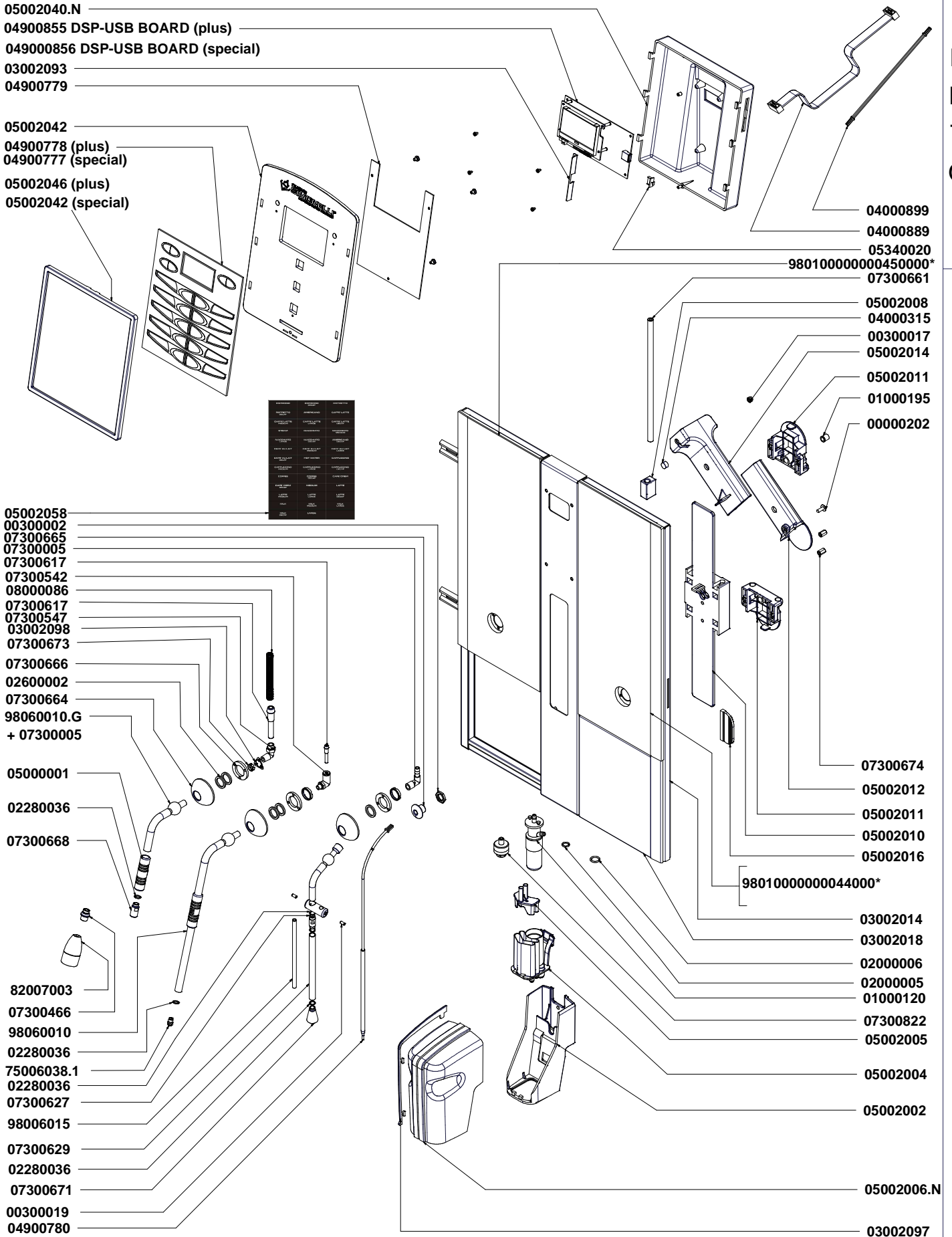

nuova simonelli

* SPECIFICARE VERSIONE E COLORE
* SPECIFY VERSION AND COLOUR

COMPONENTI GRUPPO TELAIO

FRAME COMPONENTS

T
A
L
E
N
T
O

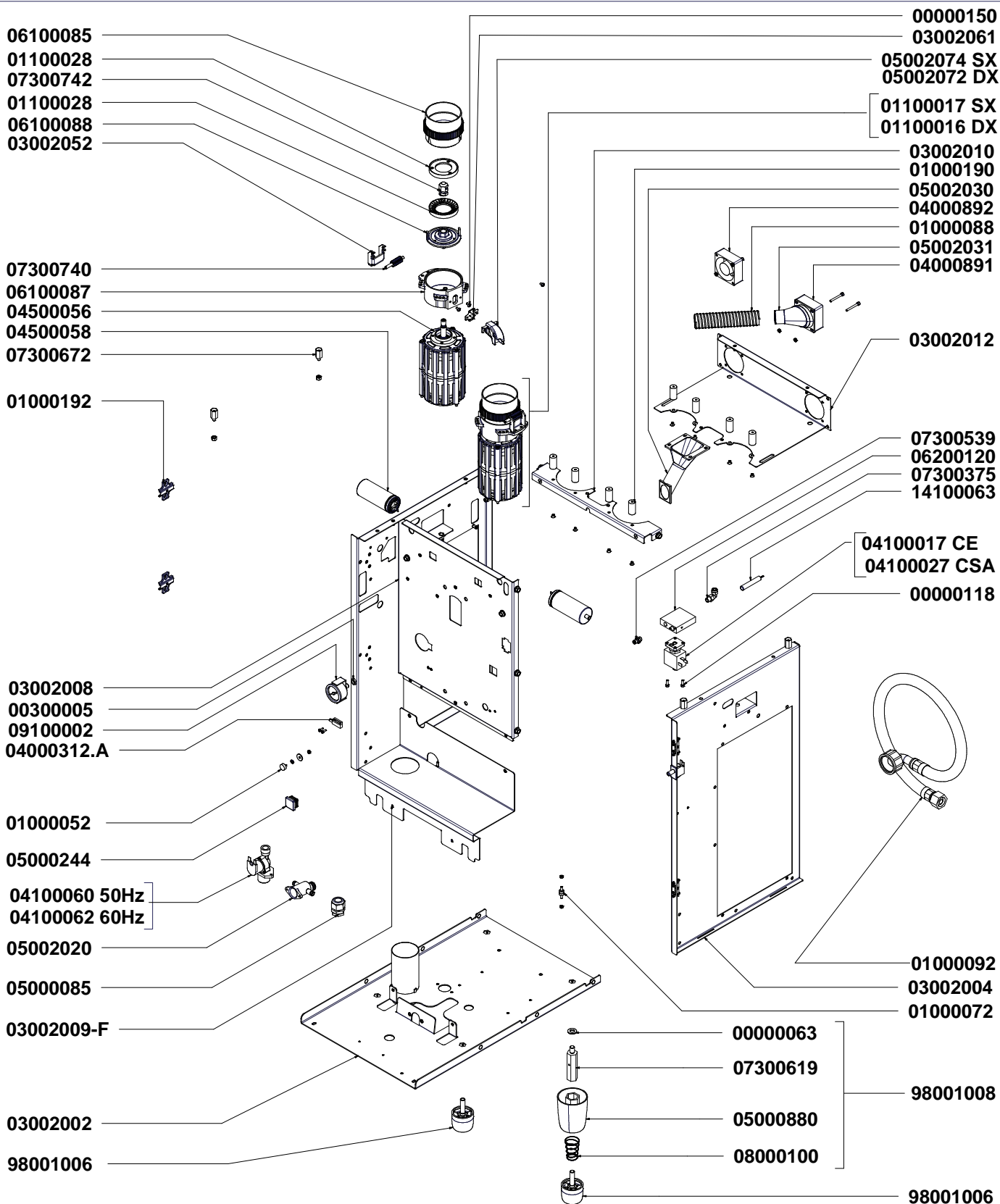

CODICE/CODE	DESCRIZIONE	DESCRIPTION
00000070	Fascetta per tubo scarico diretto fondi	Sgt clip 50/70 9 W2
00000133	Fascetta per tubo scarico diretto acqua	Stainless steel girdle WD12 16-25 C7 W2
01000080	Tubo D=60 per scarico fondi	Spiral pipe for dregs drain D=60
01000087	Tubo scarico acqua 18x24.4	Drain pipe 18x24.4

COMPONENTI LATTE MILK COMPONENTS

SPECIAL

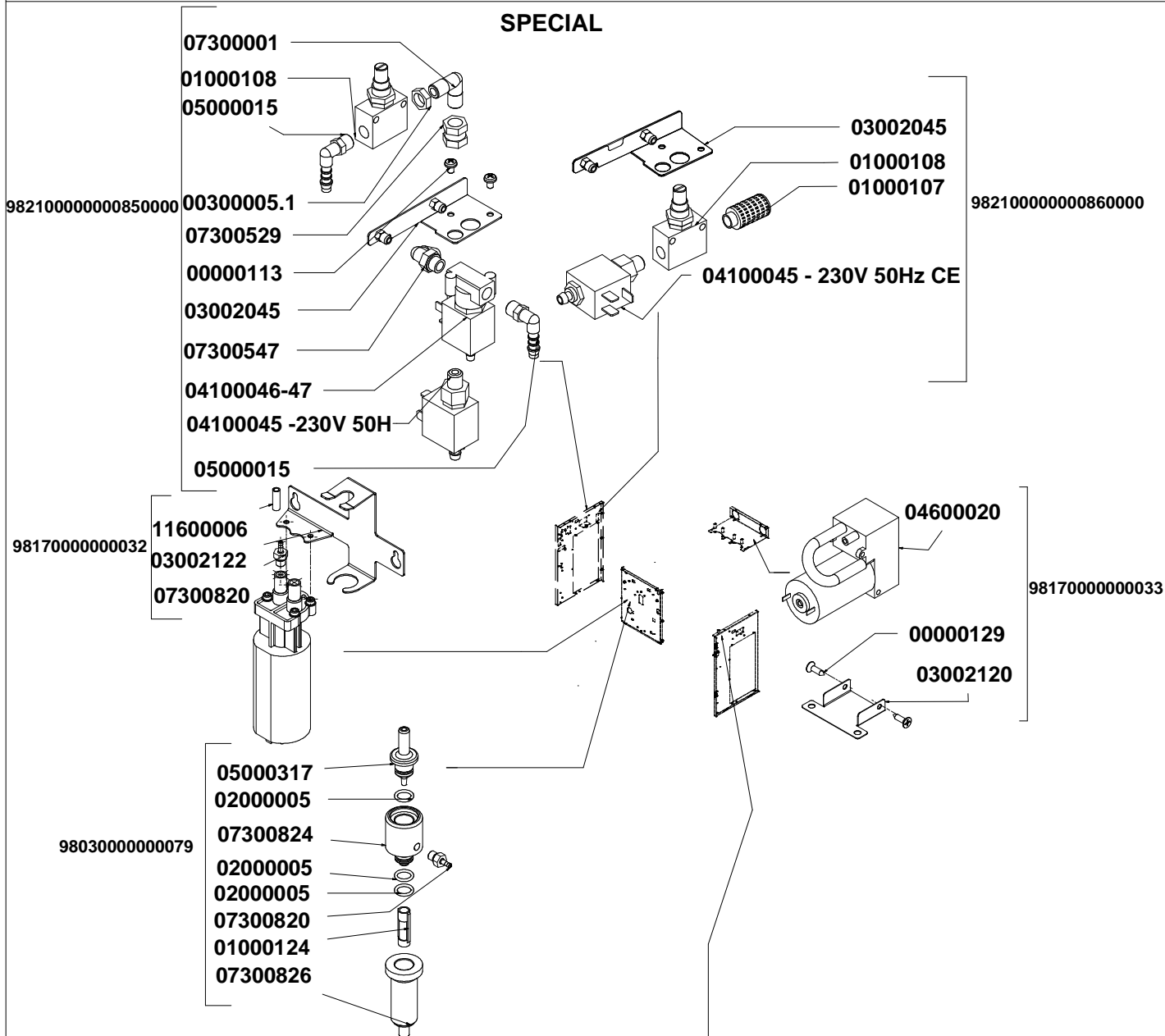

EASY CREAM

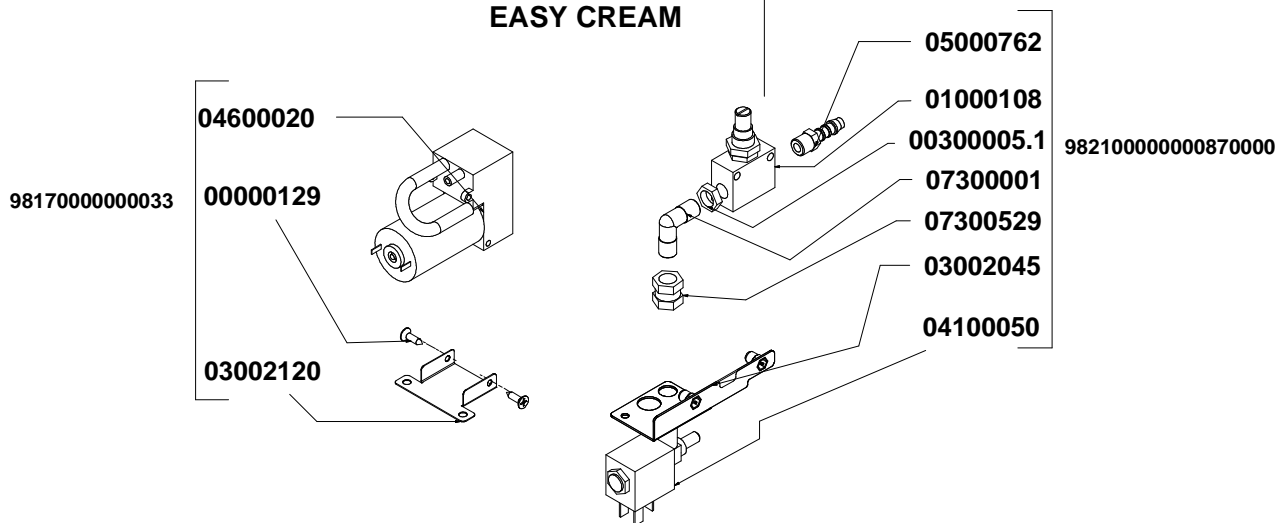

COMPONENTI GRUPPO POMPA PUMP GROUP COMPONENTS

VERSIONE STANDARD STANDARD VERSION

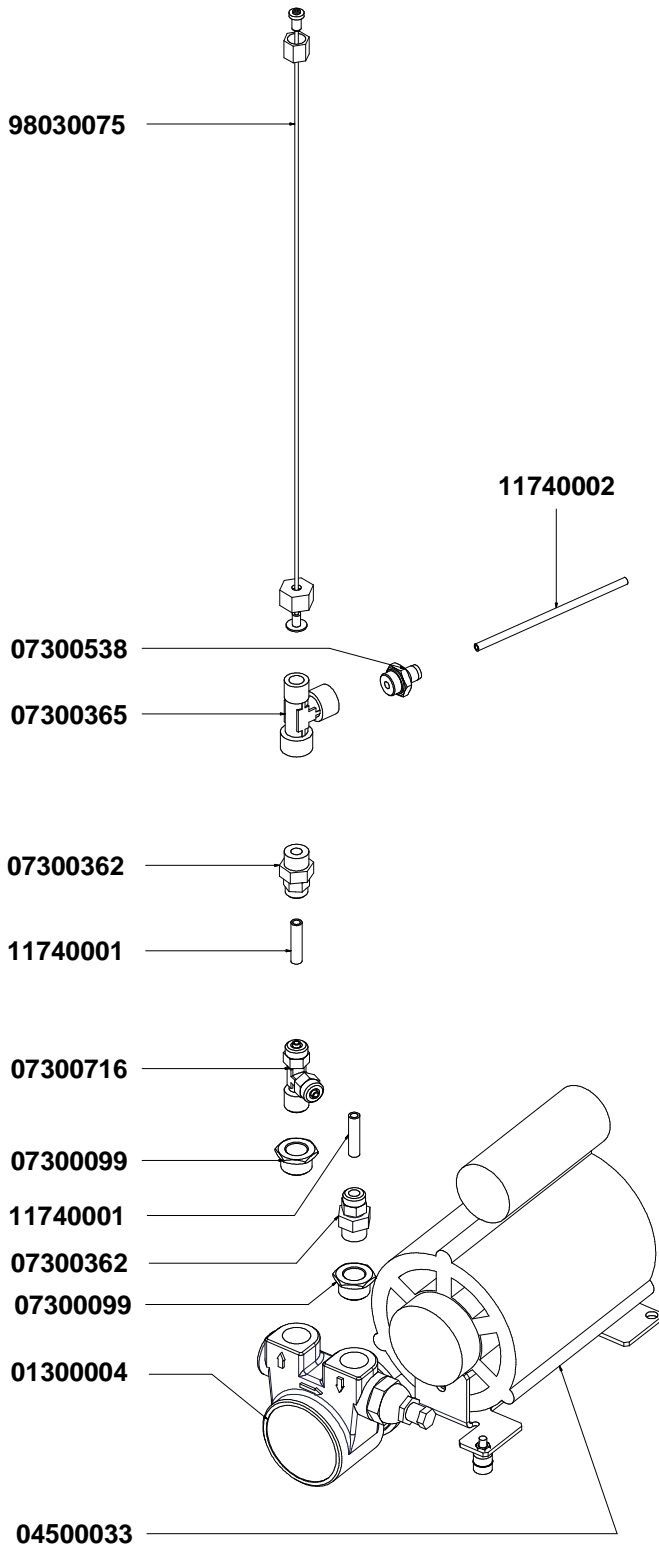

VERSIONE CON MISCELATORE ECONOMIZER VERSION

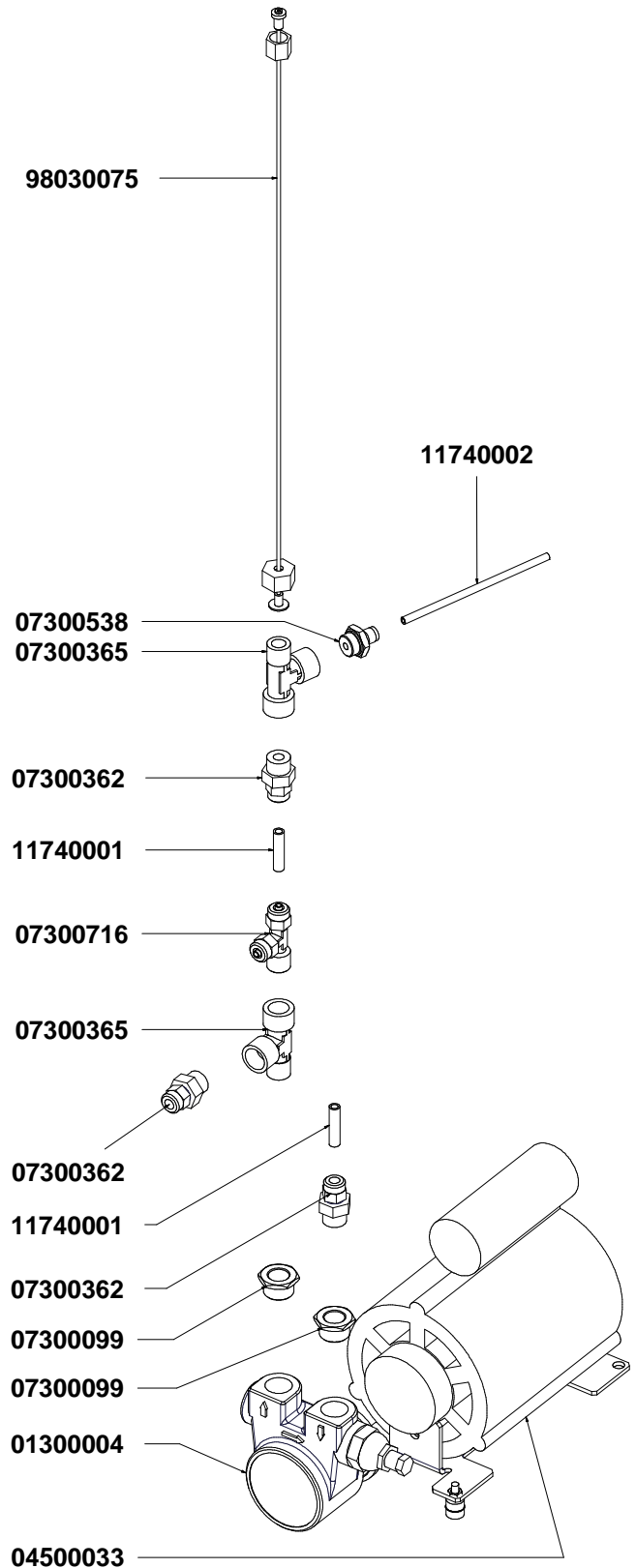

COMPONENTI IDRAULICI - VERSIONE STANDARD

HYDRAULIC COMPONENTS - STANDARD VERSION

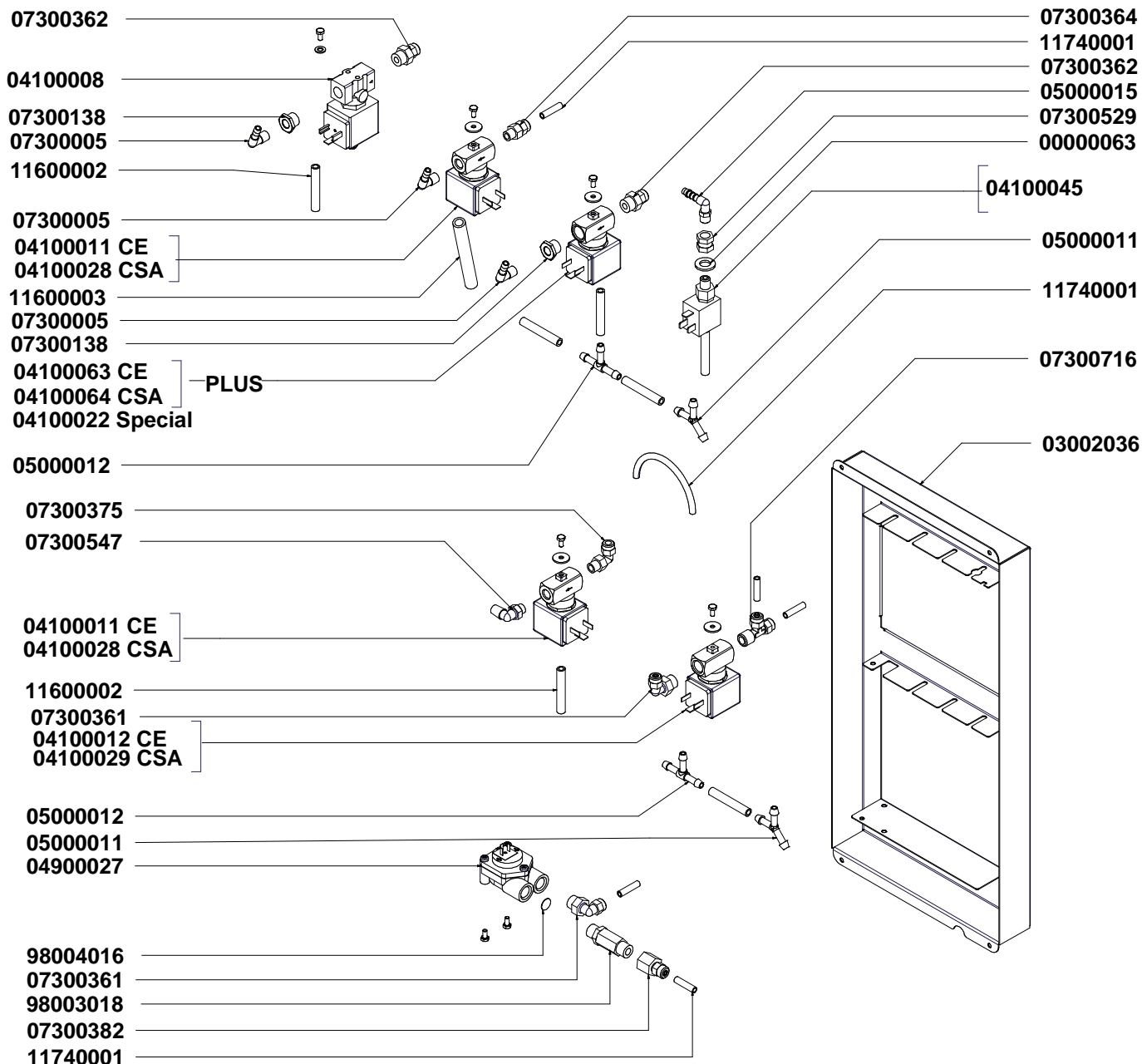

98210000000180000

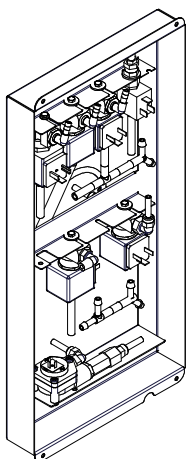

982100000000850000

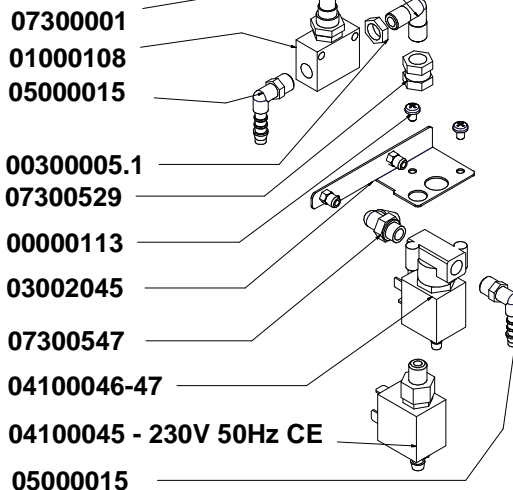

nuova simonelli

COMPONENTI IDRAULICI - VERSIONE CON MISCELATORE

HYDRAULIC COMPONENTS - ECONOMIZER VERSION

T
A
L
E
N
T
O

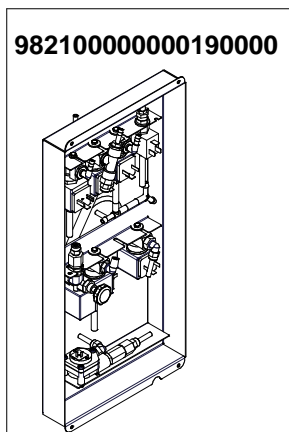
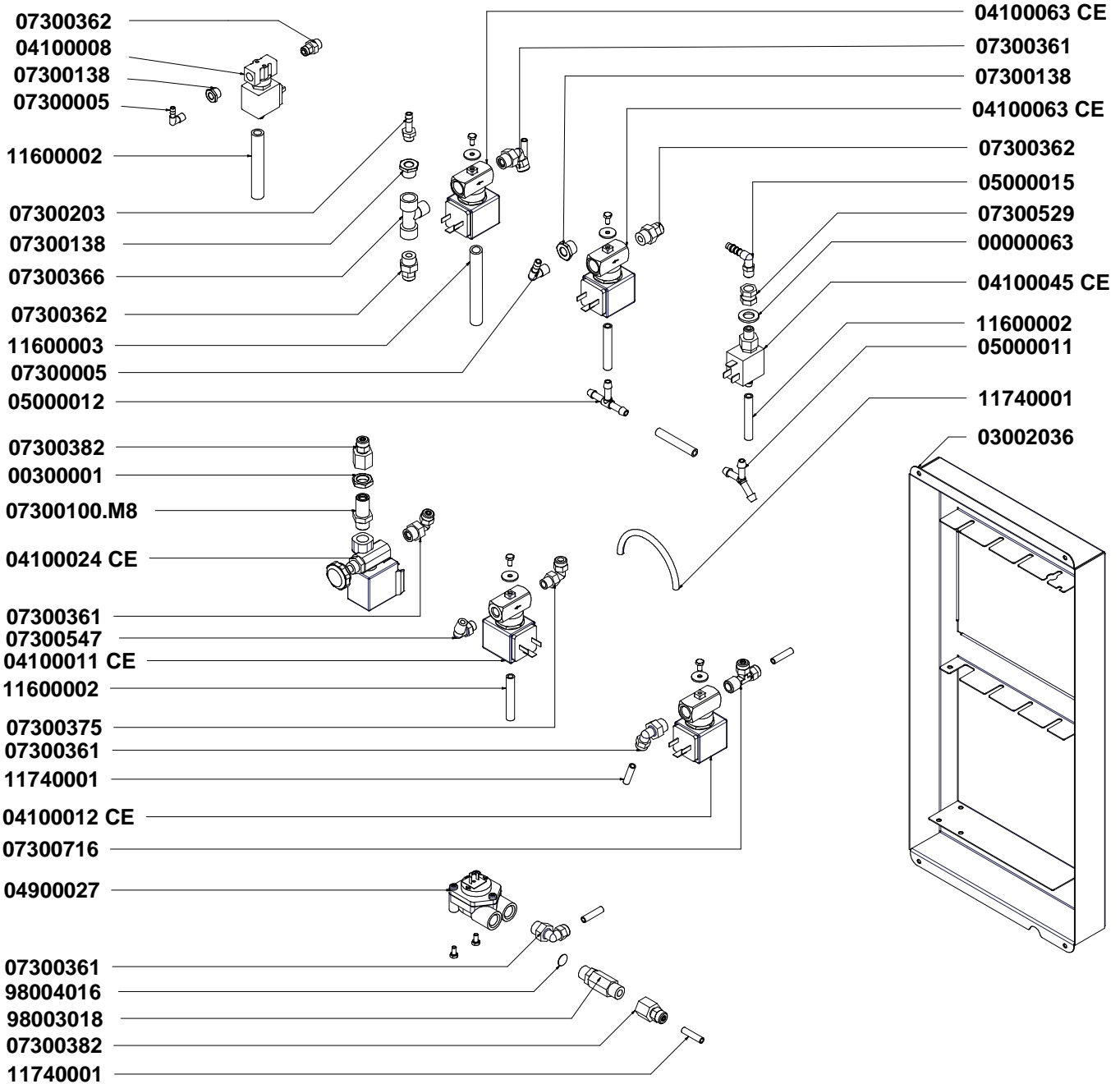

982100000000850000

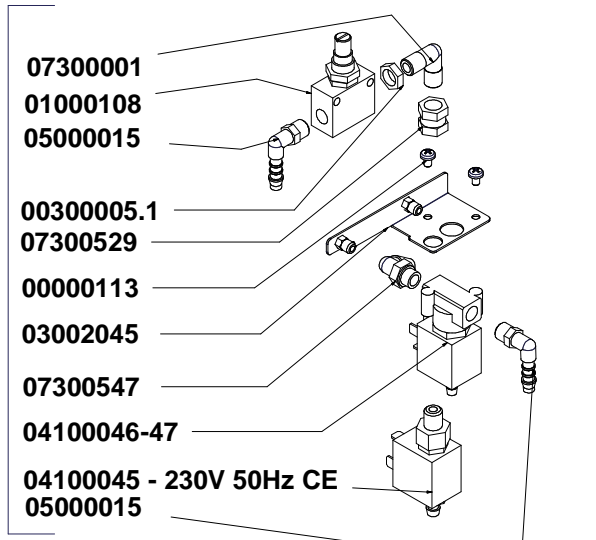

COMPONENTI GRUPPO EROGAZIONE

DELIVERY GROUP COMPONENTS

T
A
L
E
N
T
O

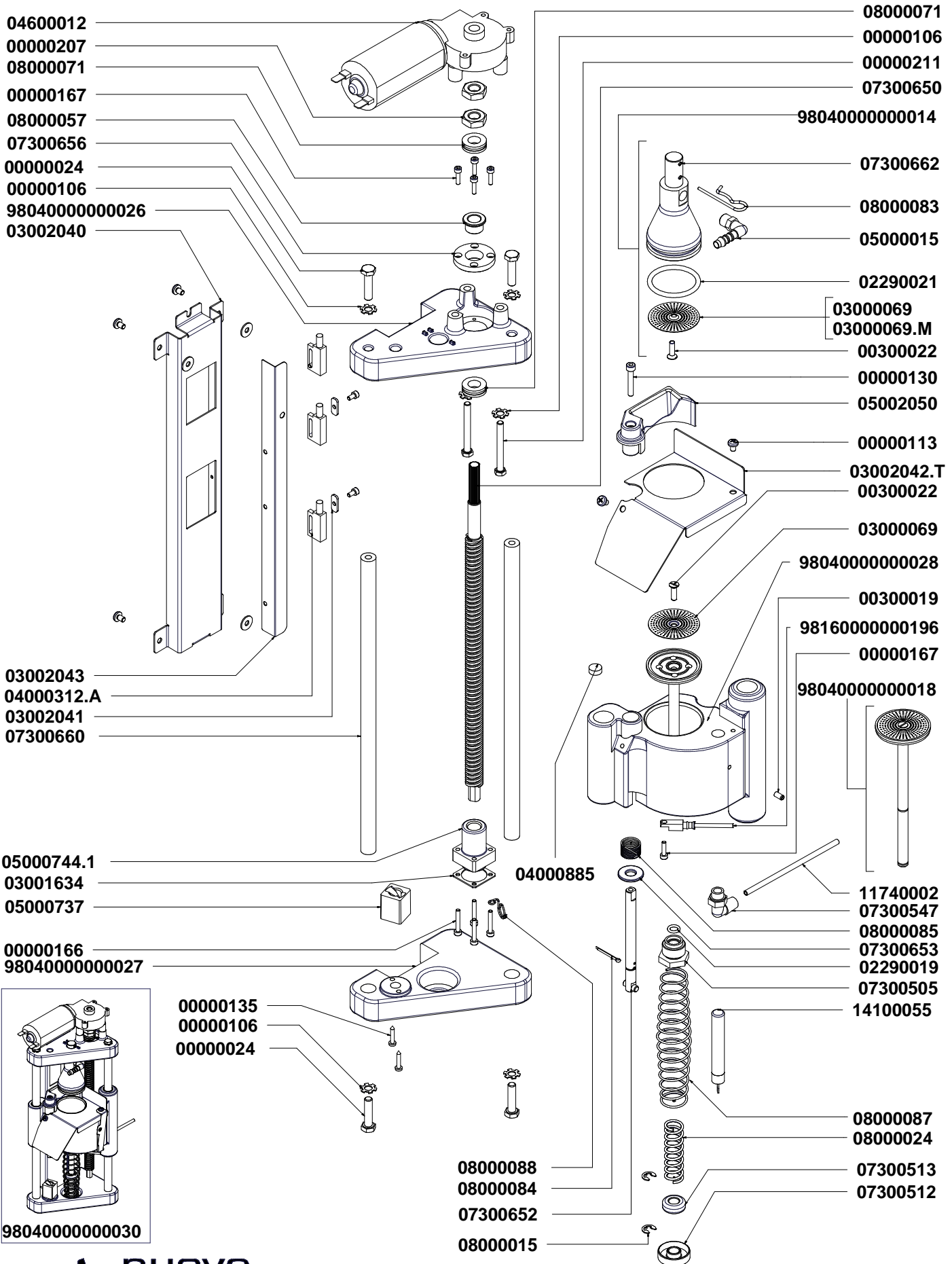

COMPONENTI GRUPPO CALDAIE

BOILERS COMPONENTS

T
A
L
E
N
T
O

98030000000870000

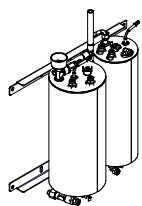

98030000000810000 CAFFE' - COFFEE
98030000000850000 VAPORE - STEAM

03000004 - CSA
09500011 - CSA

08000025
04900775
01000023

03000202
98120002 6.5bar

07300138
07300365

04000908-CSA
00300002.1

07300362
07300362
03002011

07300319
40000010

03002011
01000178
98030362
02290030.1
14100088

VERSIONE CON MISCELATORE
ECONOMIZER VERSION

98030364
07300714

VERSIONE STANDARD
STANDARD VERSION

07300129

07300009
07300063

01000180
09000005.1
03000004-CSA
09500001-CSA
01000176

48000010
07300147
98120001 16.5bar
04900775.1

07300128] VERSIONE CON MISCELATORE
ECONOMIZER VERSION

07300362] VERSIONE STANDARD
STANDARD VERSION
07300362
07300361

04000908-CSA
01000174
98030360

02290030.1
14100088

09500016 (184°C)
09500014 (167°C)-CSA

00300002.1

07300361
07300121
07300063
07300009

09500015 (184°C) CSA
09500016 (184°C)

00300002.1

07300116
07300362

COMPONENTI ELETTRICI ELECTRICAL COMPONENTS

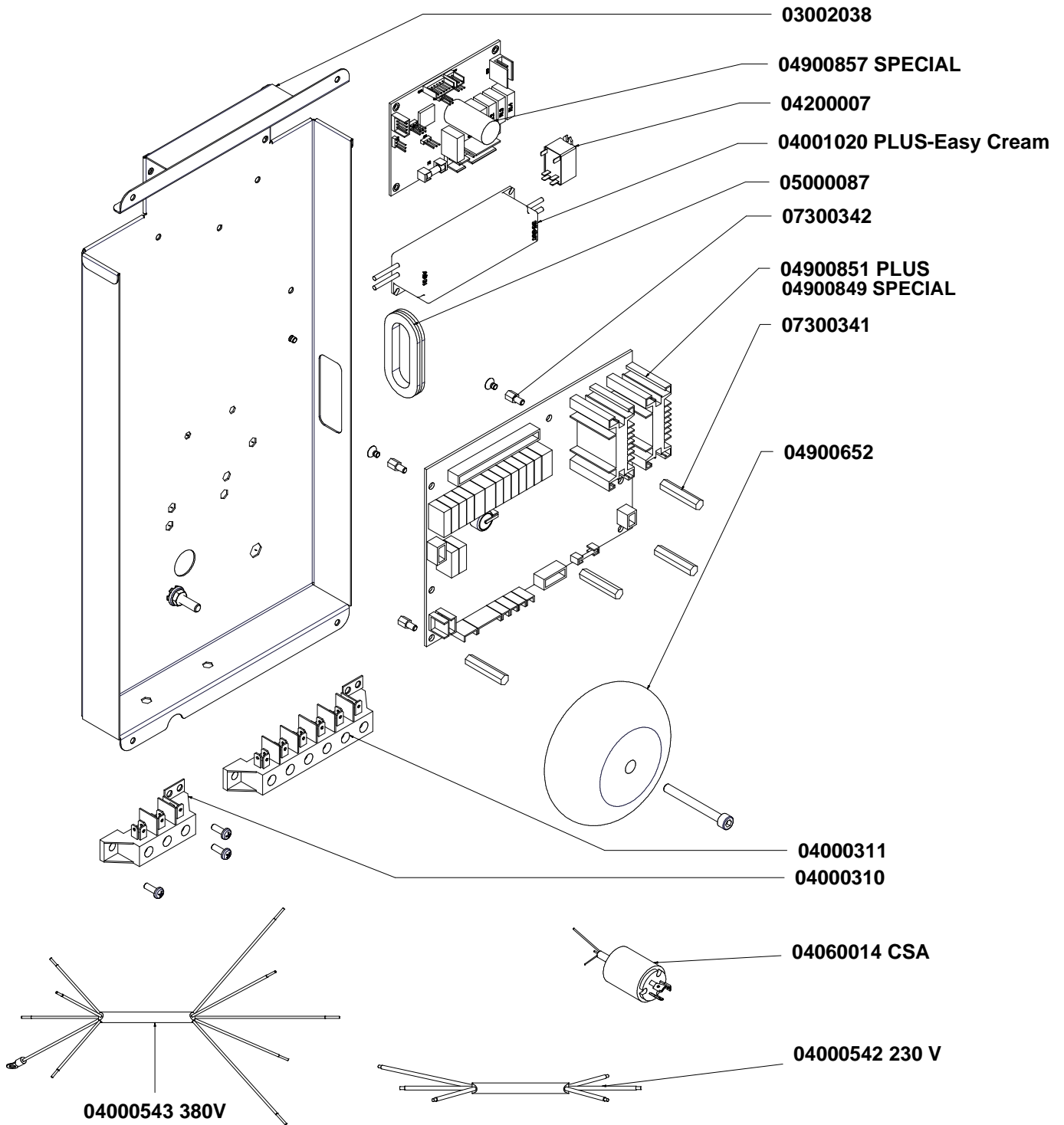

CODICE	FINE VALIDITA' VALIDITY END	DESCRIZIONE	DESCRIPTION
04000890		Impianto elettrico	Electric wiring
04000889		Cavo pulsantiera-centralina	Push button panel-junction box cable
04000888		Cablaggio motoriduttore	Electric motor cable
04000907		Cavo di terra L=130cm	Earthing cable L=130cm
04000887		Cablaggio sensori campane	Bells sensors cable
04000911		Supplemento cablaggio Special	Additional electrical wiring Special
98160000000091		assieme trasformatore + cablaggio talento plus con easy cream	transformer with + talent cabling easier with cream

CODICE	DESCRIZIONE	DESCRIPTION	END VALIDITY
11600006	TUBO SILICONE 4,8x1,6	SILICON TUBE 4,8x1,6	
11600003	TUBO SILICONE 8x12 70Sh PEROX (1mt=75gr) TRASPARENTE	SILICON TUBE 8X12 70SH PEROX TRANSPARENT	
11740001	TUBO TEFLON 6/4	TEFLON PIPE 4X6	
11740002	TUBO TEFLON 4/2,5 CALIBRATO TRASPARENTE	TEFLON PIPE 4/2.5 CALIBRATED TRANSPARENT	
14100055	RESISTENZA A CARTUCCIA HW10x65 100W 230V	CARTRIDGE HEATING ELEMENT HW10x65 100W 230V	
14100063	RESISTENZA A CARTUCCIA D10x55 18W	CARTRIDGE HEATING ELEMENT HW10x55 18W	
14100088	RESISTENZA 1"1/4 230V 2600W INCOLOY-800 A MATASSA	HEATING ELEMENT 1"1/4 230V 2600W INCOLOY-800 A COIL APPIA C	
98001006	PIEDE MACCHINA 06 BICOMPONENTE D.48 H=40	MACHINE FEET replace 98001001	
98001008	KIT PIEDI ALTI AURELIA (4 PZ)	KIT TALL FEET AURELIA (4 PCS.)	
98003018	VALVOLA RITEGNO 98 ES.16	VALVOLA RITEGNO 98 ES.16 RETAIN VALVE	
98004016	FILTRO INOX DIAM. 12	STAINLESS FILTER DIAM. 12	
98006014	TUBO LANCIA INOX VAPORE L=163 FORO 1 mm TURBOCREAM	SS STEAM TUBE L=163, HOLE 1 mm TURBOCREAM	
98006015	TUBO TEFLON 4x6 INTERNO LANCIA VAPORE L=147 mm.	TEFLON TUBE 4X6 INSIDE STEAM WAND L=147 MM.	
98030075	TUBO CAPILLARE 1/8-1/4 0,9x2x400 MANOMETRO- POMPA	CAPILLARY TUBE 1/8-1/4 0,9X2X400 MANOM.-PUMP	
98030360	CALDAIA CAFFE' D90 L=270 INOX "TALENTO"	TALENTO SS COFFEE BOILER D90 L=270	
98030364	TUBO L.160 CON RACC. 1/8 M-F MISCELATORE TALENTO	DRAFT PIPE WITH 1/8" M-F FITTING	
98060010	LANCIA VAPORE INOX D10 L=200 "TALENTO"	TALENTO SS STEAM WAND	
98060010.A	LANCIA VAPORE INOX AUTOSTEAM "TALENTO"	AUTOSTEAM AND HOT WATER SS STEAM WAND TALENTO	
98060010.G	LANCIA VAPORE INOX AUTOSTEAM ATTACCO 1/8 "TALENTO"	AUTOSTEAM 1/8" SS STEAM WAND TALENTO	
98120002	VALVOLA NEPLAX VITON 6.5 BAR 1/8 - PORTAGOMMA	NEPLAX VITON 6.5 BAR VALVE 1/8 HOSE SUPPORT	
98010000000029	ASSIEME VASCHETTA RACCOGLI ACQUA TALENTO	DRIP TRAY ASSEMBLY TALENTO	
98010000000036	CASSETTO RACCOGLIFONDI COMPL. TALENTO	DREGS DRAWER ASSEMBLY TALENTO	
98010000000037	CASSETTO RACCOGLIFONDI SCARICODIRETTO COMPL. TALENTO	DREGS DRAWER ASSEMBLY (DIRECT DRAIN) TALENTO	
98010000000039	ASSIEME CAMPANA TALENTO	COFFEE BELL ASSEMBLY TALENTO	
98020000000037	ASSIEME CHIUS.SCIVOLO MACININI TALENTO 2011	GRINDER COFFEE CHUTE ASSEMBLY TALENTO 2011	
980100000000440000	ASSIEME VETRO DX TELENTO	TALENTO RIGHT GLASS ASSEMBLY	
980100000000450000	ASSIEME VETRO SX TELENTO	TALENTO LEFT GLASS ASSEMBLY	
980300000000079	ASSIEME CAPPUCINATORE TALENTO CMK	MILK FROTHER TALENTO CMK ASSEMBLY	
980400000000028	GRUPPO TALENTO LAVORATO	MACHINED GROUP TALENTO	
980400000000030	ASSIEME GRUPPO EROGAZIONE "TALENTO 2008"	POURING GROUP ASSEMBLY "TALENTO 2008"	
981600000000091	ASSIEME TRASFORM+CABLAGGIO TALENTO PLUS	TRANSFORMER AND WIRINGS TALENTO PLUS + EASYCREAM	
981600000000196	SONDA TEMPERATURA GRUPPO TALENTO	TEMPERATURE GROUP PROBE TALENTO	
981700000000032	ASSIEME SUPPORTO + POMPA LATTE TALENTO CMK	MILK PUMP TALENTO CMK + SUPPORT ASSEMBLY	
981700000000033	ASSIEME SUPPORTO + MICROCOMPRESSORE TALENTO	MICROCOMPRESSOR TALENTO + SUPPORT ASSEMBLY	
9803000000000810000	ASSIEME CALDAIA CAFFE' TALENTO 2011	COFFEE BOILER ASSEMBLY D=90 L=270 TALENTO 2011	
9803000000000850000	ASSIEME CALDAIE VAPORE TALENTO 2011	STEAM BOILER ASSEMBLY D=115 L=270 TALENTO 2011	
9803000000000870000	ASSIEME CALDAIE TALENTO 2011	BOILERS ASSEMBLY TALENTO 2011	
982100000000190000	ASS.SUPPORTO E.V. + DOSATORE TALENTO 2011 C/MISCELAT.	E.V. GROUP ASSEMBLY TALENTO 2011 ECONOMIZER VERSION	
9821000000000850000	ASS.SUPPORTO E.V. ARIA + PULIZIA TALENTO CMK	AIR+AUTOWASHING VALVES ASSEMBLY TALENTO CMK	
9821000000000860000	ASS.SUPPORTO E.V.+REGISTRO ARIA TALENTO CMK	AIR REGULATOR + VALVES ASSEMBLY TALENTO CMK	
9821000000000870000	ASS.SUPPORTO E.V.+REGISTRO ARIA EASY CREAM TALENTO	EASYCREAM AIR REGULATOR + VALVES ASSEMBLY TALENTO	

T
A
L
E
N
T
O